



INSTALLATION INSTRUCTIONS

VEHICLE APPLICATION

Year: **2003-07**
Make: **Dodge**
Model: **Ram 2500, 3500**
Engine: **5.9L Cummins Diesel**

TOOLS REQUIRED

- 10mm, 13mm, 1/2" Wrench & Socket
- 7/16" Deep Socket
- 3/16" & 6mm Hex Drive
- Torque Wrench (In.lb.)
- Gasket Remover (Scraper)
- Vacuum

CAUTION

Use a 1/4 inch drive ratchet. NOTE: All required torque specs. are called out in **Inch pounds** **NOT** foot pounds!

BEFORE YOU START

- Please read the entire product guide before proceeding.
- Ensure all components listed on page 4 are present.
- If you are missing any of the components, call our customer support at (909) 947-0015.
- Do not attempt to work on your vehicle while engine is hot.
- Make sure the engine is turned off and the vehicle is in Park or the Parking Brake is set.

1. With the ignition switched off and the parking brake set, disconnect the negative battery cables on both batteries.



2. Loosen the upper hose clamp at the OE elbow and disconnect the hump hose from the elbow. **Note:** Care should be taken not to let any debris fall into the boost tube.



3. Remove the bolt that secures the dip stick tube to the elbow.



4. Remove the lock nut and pull the prong out that secures the wiring harness to the elbow and push the harness back away from the elbow.



5. Remove the 4 bolts that secure the elbow to the manifold and remove the elbow from the vehicle. Careful not to let any debris fall into the manifold. **Note:** If the OE bolt threads were corroded and rust deposits have fallen through the bolt holes into the manifold use a vacuum to clean it out.

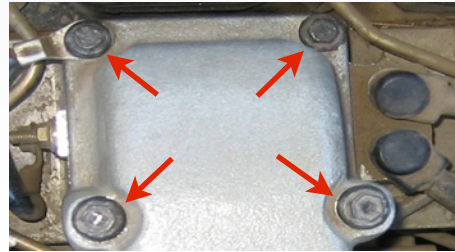

6. Remove the screw that secures the ground wire to the manifold to gain access and to remove both gaskets. A scraper may be necessary, be careful not to damage the sealing surface and to not let any debris fall into the manifold. You may need a vacuum at this step as well.

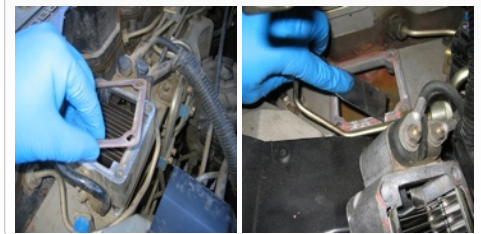

7. Place the supplied Graphite Gasket (I) on the manifold under the heater block, make sure all four bolt holes in the gasket line up correctly.



8. This kit has 2 long studs (J) and 2 short studs (H), to determine the correct stud length for your truck, thread each a long and short stud (short threaded end first) into the manifold bolt holes farthest from the valve cover. Measure the height of the stud from the heater grid block upward. Use the studs that are approximately 1.125".



SEE EXPLODED VIEW ON PAGE 4



INSTALLATION INSTRUCTIONS (Continued)

9. Remove the studs and place a small amount of the supplied Thread Locker (N) to the correct size Studs (J or H) and thread the studs by hand into the two bolt holes farthest from the valve cover. Stage the Socket Cap Screws (E) by applying Thread Locker also.

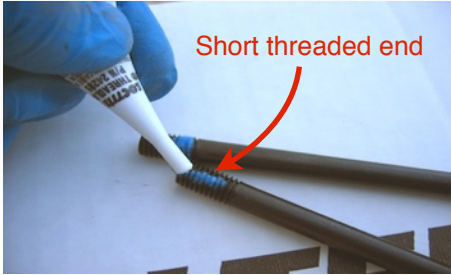

10. Double nut a stud using the supplied Jam Nuts (K). Turning only the top nut, torque the stud to 40 In. lbs. Remove the Jam nuts and repeat process on the other stud then discard the Jam nuts. **Note:** You should first place a clean shop towel in the opening of the intake manifold to prevent any debris from falling inside.



11. Apply a thread sealant such as Teflon tape to each 1/8" NPT plug (G) and insert the plugs into the ports you will not use on the S&B elbow. Use a 3/16 hex socket and tighten, do not exceed 40 In. lbs.



12. Install the large end of the Silicone hump hose (O) over the end of the Elbow (F) and secure using the supplied T-bolt clamp (P). Torque the clamp to 90 In. lbs.



13. Place the other supplied Gasket (I) over the Studs on top of the heater grid block.



14. Remove the OE nut at the lower dip stick tube bracket and carefully push the tube back about one inch.



15. Slide the OE t-bolt clamp down the intercooler tube. Push the silicone end of the elbow assembly down over the intercooler tube. Then rotate the elbow assembly over the studs on the heater grid.

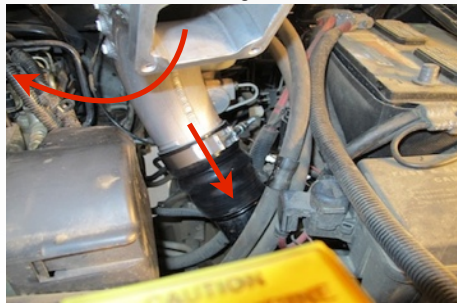

16. Install the two M8 Socket head screws (E) and M8 washers (D) through the two holes. Hand tighten for now.

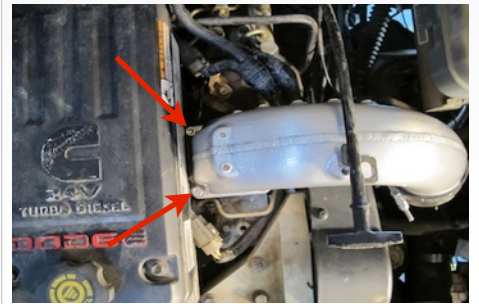

17. Place a M8 washer (D) over each stud and thread on the M8 lock nuts (C). Torque both the lock nuts and the screws to 145 In. lbs. If you use a crow foot to torque the nuts, see the crow foot calculation on page 3. If there was a ground wire connected to the manifold, place it back in the same location.



18. Slide the OE t-bolt clamp up onto the Silicone adapter (O) and torque the clamp to 90 In. lbs.



SEE EXPLODED VIEW ON PAGE 4



INSTALLATION INSTRUCTIONS (Continued)

19. Secure the dip stick tube upper bracket to the Elbow. Apply thread locker to the 5/16" x 1/2" Bolt (B). Then place the Flat Washer (A) on the 5/16" x 1/2" Bolt (B). Place the bolt and washer through the upper bracket and place the Rubber Washer (M) and the other Flat Washer (A) under the bracket and thread the bolt into the elbow and secure. Do not exceed 30 In. lbs. If applicable, re-attach the dipstick bracket to the stud that was removed in step #14.



20. Use the supplied Zip-tie (L) to secure the wiring harness behind the elbow that was removed in Step #4.



21. Reconnect both batteries. Inspect your installation, make sure the kit is properly positioned and all fasteners are secure. Affix the CARB sticker near the intake kit. The installation is now complete.



PERFORMANCE TESTING

- Engage parking brake and start your engine. Listen for abnormal noises. If an air leak is detected, re-inspect hoses and connections as they may need to be repositioned and tightened.
- S&B FILTERS recommends that you keep your OE intake elbow in the event it is required in the future.
- In order to maintain your warranty, all connections and components must be checked periodically for alignment and for proper tension on all connections. Failure to do so may void your warranty.

Crow Foot Calculation

NOTE: This is a calculation to adjust your Torque Wrench for use with a Crow Foot attached. Please note the end value will never be higher than the original torque value.

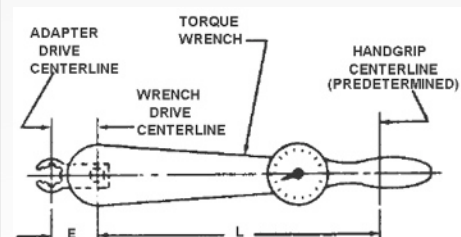

$$\text{FORMULA } \frac{T \times L}{L + E} = Y$$

EXAMPLE: (WITH "E" AS PLUS DIMENSION)

$$T = 135 \text{ LB. IN.} \quad Y = \frac{135 \times 10}{10 + 1.5} = \frac{1350}{11.5} = 117.39$$

Y = UNKNOWN

L = 10.0 IN.

E = 1.5 IN. Y = 117 LB. IN.

RELATED ITEMS FOR YOUR PURCHASE

- Cold Air Intake System (S&B P/N: 75-5047)
- Ram Air Scoop (S&B P/N: 75-5049)
- Heater Delete Block (S&B P/N: 76-1005)

EMISSIONS STANDARD

The California Air Resource Board (CARB) requires that an E.O. identification label be applied to the vehicle in order to pass a smog check inspection when a Performance Intake Kit has been installed. You must place the E.O. label provided on or near the intake kit after installation so that a smog check technician can easily verify the E.O. number. As of April 2009, S&B has never had a product where CARB denied an exemption request; however, the exemption process with CARB can take as long as 18 months. Check the status of the exemption process by looking up a specific part number at www.sbfilters.com. The CARB Exemption number and/or status is listed under the Product Details section for each part number. If the status shows as "Pending," CARB has yet to issue an exemption. Products that have not been issued an EO number are street legal in most states, but may not be used on emission controlled vehicles in the state of California and are for off road use only. If you purchased your kit from S&B Filters directly, we will automatically mail you your Exemption Sticker when it is issued to us. If you purchased your kit from an authorized S&B Filters Dealer, log onto our web site and register to receive your Exemption Sticker.

SEE EXPLODED VIEW ON PAGE 4



EXPLODED VIEW

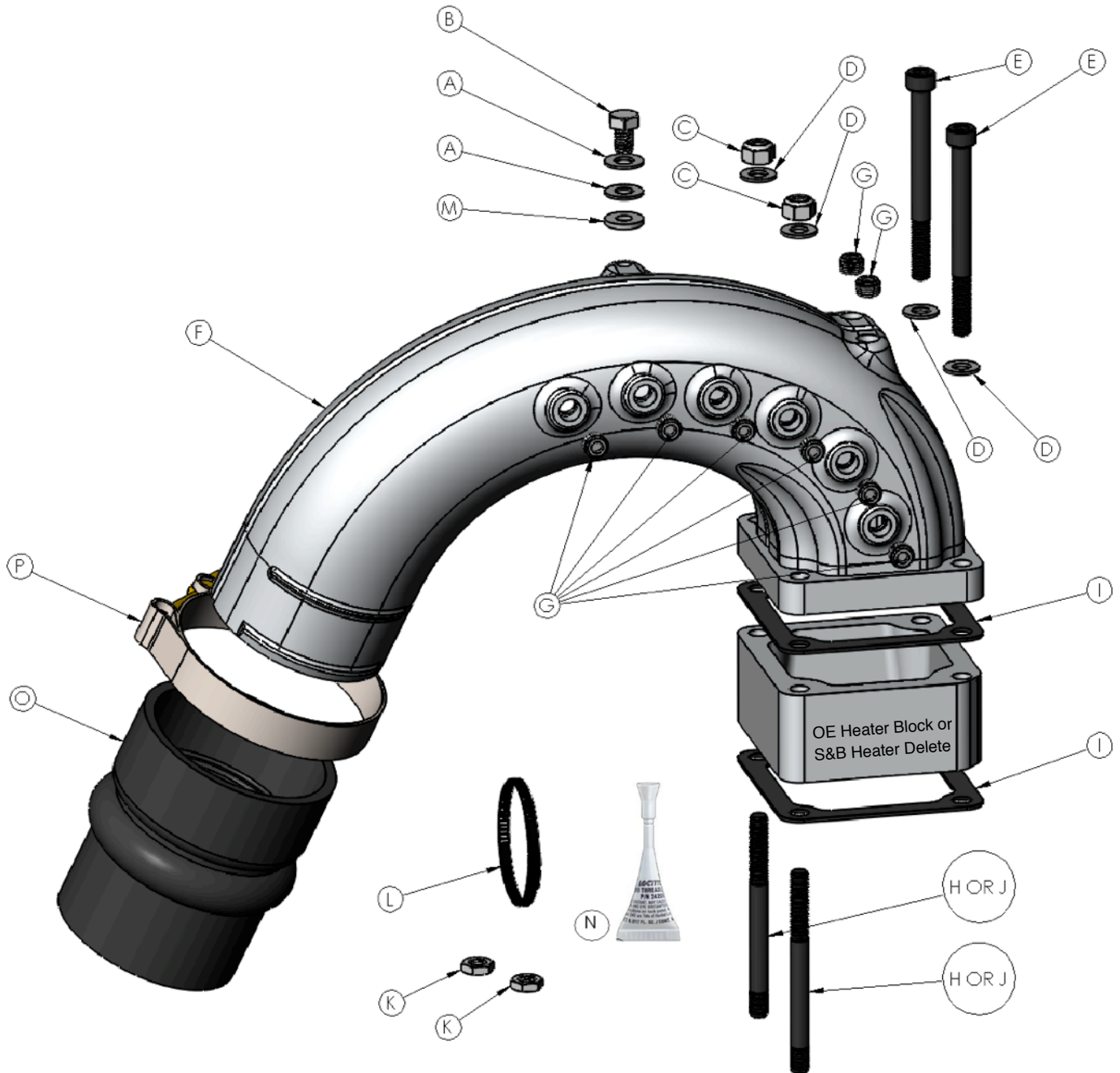

ITEM	QTY.	DESCRIPTION	P/N
A	2	Washer, Flat, 5/16"	AI1073-00
B	1	Bolt, Hex, 5/16-18x1/2"	AI1078-00
C	2	Nut, Hex, Nylock, 8mm	AI1401-00
D	4	Washer, Flat, 8mm	AI1402-00
E	2	Cap Screw, Socket, M8x90mm	AI1424-00
F	1	Intake Elbow	AL1174-00
G	8	Pipe Plug, 1/8"NPT	AI1398-00
H	2	Stud, Double End, M8x85mm	AI1408-00
I	2	Gasket, Flat, 4-Hole	AI1532-00
J	2	Stud, Double End, M8x95mm	AI1400-00
K	2	Nut, Hex, Jam, 8mm	AI1405-00
L	1	Zip-Tie, Black, 11"	AI1212-00
M	1	Rubber Washer	AI1435-00
N	1	Loctite Thread Locker	AI1406-00
O	1	Silicone Hump Hose	AI1530-00
P	1	T-Bolt Clamp,	AG1031-00

AM0173-00 RevA 12/19/11



INSTALLATION INSTRUCTIONS Addendum

How to choose the correct stud length.

This instruction sheet addendum will help you determine the correct stud length to use. This procedure will take place during steps #8 and #9 of the original installation instructions.

Some of our competitors accommodated a bolt through design to ease the installation process, we feel this to be of a poor design. Because S&B Filters believes this type of product installation is a one time deal. Our superior design warrants the additional installation time, as it will yield better performance. S&B Filters gained maximum flow numbers with an aggressive design that left a small window of clearance for a fixed stud height. This step will add an additional 5 to 10 minutes to the installation. This kit includes 2 long studs (95mm) and 2 short studs (85mm). To determine the correct length studs for your application you will need to thread each, a long and short stud (short threaded end first) into the manifold bolt holes farthest from the valve cover. Measure the height of the stud from the heater grid block upward. Use the stud set that comes closest to 1-1/8" (1.125") in height. Remove the studs, place a small amount of the supplied Thread Locker to the correct Studs and thread the studs by hand into the two bolt holes farthest from the valve cover. Then use the double nut method to secure and torque the studs to approximately 40 inch lbs. **NOT** foot lbs.

During this process care should be taken to prevent any parts or debris from falling into the intake manifold by sealing the opening with duct tape or covering it with a shop towel. If you do get debris inside the manifold you can use a shop-vac or household vacuum with a small tip attachment to clean out any debris. If you drop a stud or jamb nut into the manifold try fishing it out with a mechanics magnetic pick-up tool or something similar.

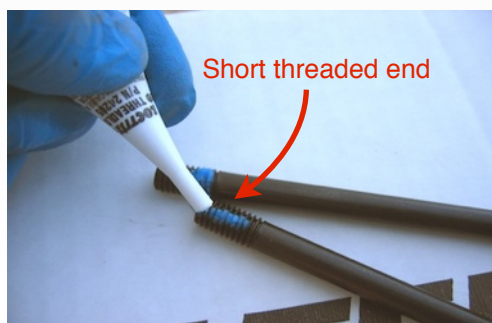

Intake Elbow Product Warranty

The warranty period for S&B Intake Elbows is 5-Years. Returns are not accepted once the parts have been installed.

Never operate the vehicle (including but not limited to a dyno run) with the hood raised as serious injury and or death could occur!

Warranty Conditions

Product returned for warranty resolution must be accompanied by a Return Material Authorization (RMA) number obtained in advance from an S&B customer service representative. S&B will be the final authority on all warranty decisions.

The original consumer who purchased the S&B product must also provide proof of purchase to be eligible for the warranty. Those S&B products used in any type of racing or for off-road use are not covered by the warranty. S&B products that are modified or that are used on custom applications are also not covered. Products made and/or sold by S&B on a private label basis are also not covered by the warranty.

This warranty shall not apply to any unit which has been improperly stored or installed; subjected to misapplication, improper operating conditions, accidents, or neglect; or which has been improperly repaired or altered or otherwise mistreated by the owner or his agent.

Warranty Coverage

S&B Filters, Inc. (S&B) warrants to the original purchaser that any parts purchased shall be free from defects in material and workmanship. A defect is defined as a condition that would render the product inoperable. This warranty does not cover deterioration of plating, paint or any other coating. S&B's liability is limited to the repair or replacement, at S&B's option, of any warrantable product returned prepaid with a complete service history and proof of purchase to the factory. A valid proof of purchase is a dated bill of sale. Repaired or replaced product will be returned to the customer freight collect. Accepted warranty units which have been replaced become the sole property of S&B. Mileage is not a factor. All S&B products are subject to the provisions stated herein regardless of mileage.

Except as set forth in this warranty, S&B disclaims any implied warranty, including implied warranties of merchantability and fitness for a particular purpose. **S&B also disclaims any liability for incidental or consequential damages including but not limited to, repair labor, rental vehicles, hotel costs or any other inconvenience costs.** This warranty is in lieu of all other warranties or guarantees, either expressed or implied, and shall not extend to any consumer or to any person other than the original purchaser residing within the boundaries of the continental U.S. or Canada.

Warranty does not cover conditions where heat-damage resulted due to overly-rich fueling conditions.